

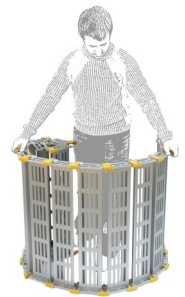

Quick Reference Guide & Owner's Manual

Unroll Roll-A-Ramp®



Turn ramp and place top two elements onto top step – (angled plate + 1st ramp link)





ROLL-A-RAMP

Where Strength and Flexibility Meet



- Place at least the first two sections of
1. Roll-A-Ramp on the top step and it is ready for use.

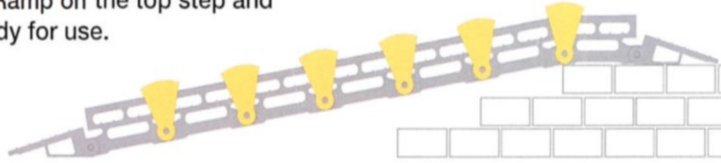

2. Roll-A-Ramp's unique design makes it ideal for thresholds, without the need for any added accessories.

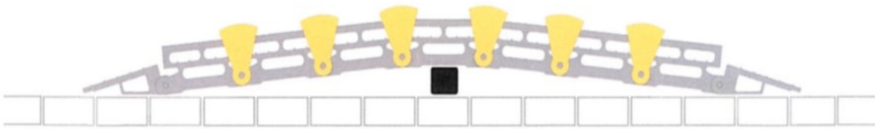

3. Roll-A-Ramp can easily be used to bridge gaps.



4. With our optional 'Seg-mount' (#3150), Roll-A-Ramp can be placed flush with the top step so you can close a door with the ramp in place.

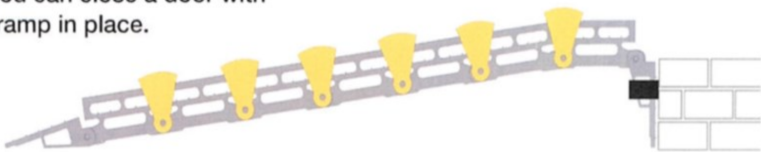

IMPORTANT At least the top two pieces of the ramp must sit on the top step. The maximum weight the ramp can hold is 1,000lbs (450kg)

30" (76.2cm) Width Single Ramp

Total Ramp Length		Total Load Bearing Length		Total Weight of Ramp		Maximum Allowable Spread Load	
Ft	M	Ft	M	Lbs	Kg	Lbs	Kg
5	1.52	4	1.22	26	11.8	1000	453.6
7	2.13	6	1.83	36	16.4	1000	453.6
9	2.74	8	2.44	46	21	1000	453.6
10	3.05	9	2.74	51	23.2	875	396.9
11*	3.35	10	3.05	56	25.5	800	362.9
12*	3.66	11	3.35	61	27.7	725	328.9
13*	3.96	12	3.66	66	30	650	294.8

36" (91.44cm) Width Single Ramp

Total Ramp Length		Total Load Bearing Length		Total Weight of Ramp		Maximum Allowable Spread Load	
Ft	M	Ft	M	Lbs	Kg	Lbs	Kg
5	1.52	4	1.22	30	13.6	1000	453.6
7	2.13	6	1.83	42	19.1	1000	453.6
9	2.74	8	2.44	54	24.5	850	386.4
10	3.05	9	2.74	60	27.3	775	352.3
11*	3.35	10	3.05	66	30	700	318.2
12*	3.66	11	3.35	72	32.7	625	284.1
13*	3.96	12	3.66	78	35.5	550	250

**For lengths over 13ft (3.96m)
CONSULT ROLL-A-RAMP®**

Toll-Free 1-866-883-4722 sales@rollaramp.com rollaramp.com

Toll-Free 1-866-883-4722 sales@rollaramp.com rollaramp.com

Distributed Weight Maximum Loads

Tables show Total Length, Load Bearing Length, Weight and Maximum Spread Load Weight Rating for Roll-A-Ramp®.

12" (30.48cm) Width—Each Single Channel

Total Ramp Length		Total Load Bearing Length		Total Weight of Each Ramp		Maximum Allowable Spread Load	
Ft	M	Ft	M	Lbs	Kg	Lbs	Kg
5	1.52	4	1.22	16	7.3	2000	907.2
7	2.13	6	1.83	22	10	2000	907.2
9	2.74	8	2.44	28	12.7	2000	907.2
10	3.05	9	2.74	31	14.1	1750	793.8
11*	3.35	10	3.05	34	15.5	1600	725.8
12*	3.66	11	3.35	37	16.8	1450	657.7
13*	3.96	12	3.66	40	18.2	1325	601.0

26" (66.04cm) Width Single Ramp

Total Ramp Length		Total Load Bearing Length		Total Weight of		Maximum Allowable	
Ft	M	Ft	M	Lbs	Kg	Lbs	Kg
5	1.52	4	1.22	22	10	1000	453.6
7	2.13	6	1.83	30	13.6	1000	453.6
9	2.74	8	2.44	38	17.3	1000	453.6
10	3.05	9	2.74	42	19.1	875	396.9
11*	3.35	10	3.05	46	21	800	362.9
12*	3.66	11	3.35	50	22.7	725	328.9
13*	3.96	12	3.66	54	24.5	650	294.8

***IMPORTANT NOTE - Ramps of total length of 11ft (3.35m) and over MUST be used with Center Support Stands. Position the supports at the center of the span and on the sides perpendicular to the span center.**

Toll-Free 1-866-883-4722 sales@rollaramp.com rollaramp.com

RAMP PLACEMENT METHODS FOR YOUR ROLL-A-RAMP®

There are three options to position the upper ramp at the top landing. All ramps are shipped ready to set up with Standard Ramp Placement shown in #1 with the non load-bearing Approach Plate unless other options are ordered (see below)

Ramps are designed to be securely setup without the need for brackets or anchoring the ramp, although they can be if needed.

Choose the Placement Option that best suits your situation.

Placement Option #1 Standard Approach Plate (included)

This is how the ramp is shipped, using the **Standard Approach Plate** included with all ramps. This plate plus a ramp link must rest on the landing (12" total)

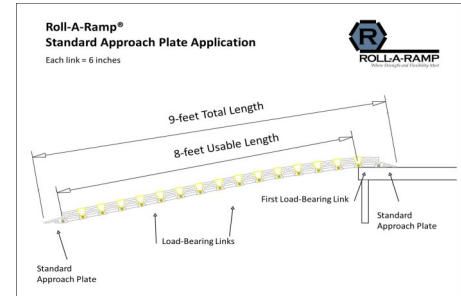

Placement Option #2 Load Bearing Approach Plate (optional)

This end piece only rests on the landing edge for a smoother ramp transition. A smoother wheelchair experience and hand dollies, etc.



Width options:
 #3226 (26")
 #3235 (30")
 #3236 (36")
 #3248 (48")

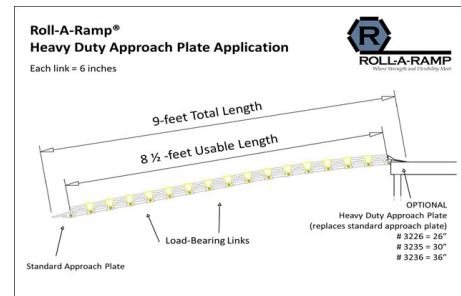

Placement Option #3 #3150 Seg Mount Brackets (optional)

Mounted to the vertical surface of the landing they provide a more flush transition onto the ramp. Does not require the 1st link of ramp to rest on the landing in addition, saving space. Ramp can easily be removed. Recommended when 12" is not available on the landing surface for **Standard Ramp Placement (#1)**, or if desired.



Ramp Length Calculation Chart
 (for steeper slope angles contact us 1-866-883-4722)
 See bottom for type of use

7-Degree = Rise (in.) / 1.5		10-Degree = Rise (in.) / 2	
RISE Distance (inches)	RAMP LENGTH	RISE Distance (inches)	RAMP LENGTH
7"	5 FT	7"	4 FT
8"	6 FT	8"	5 FT
9"	7 FT	9"	5 FT
10"	7 FT	10"	6 FT
11"	8 FT	11"	6 FT
12"	9 FT	12"	7 FT
13"	9 FT	13"	7 FT
14"	10 FT	14"	8 FT
15"	11 FT	15"	8 FT
16"	11 FT	16"	9 FT
17"	12 FT	17"	9 FT
18"	13 FT	18"	10 FT
19"	13 FT	19"	10 FT
20"	14 FT	20"	11 FT
21"	15 FT	21"	11 FT
22"	15 FT	22"	12 FT
23"	16 FT	23"	12 FT
24"	17 FT	24"	13 FT
25"	17 FT	25"	13 FT
26"	18 FT	26"	14 FT
27"	19 FT	27"	14 FT
28"	19 FT	28"	15 FT
29"	20 FT	29"	15 FT
30"	21 FT	30"	16 FT
31"	21 FT	31"	16 FT
32"	22 FT	32"	17 FT
33"	23 FT	33"	17 FT
34"	23 FT	34"	18 FT
35"	24 FT	35"	18 FT
36"	25 FT	36"	19 FT
Manual wheelchairs assisted & Unassisted, power W/C's & walking		Manual wheelchairs assisted/ power W/C's – walking (w/ handrail)	

6. **Periodic Maintenance:** It is essential that you check your ramp at least every six months for signs of damage or excessive wear and tear. Particular attention should be given to ensure all the connecting nuts, bolts and yellow pinch guards are in place and correctly tightened (do not overtighten). Clean all surfaces with a mild detergent solution to remove any oil, grease or other deposits.
7. **Thresholds:** To compensate for the height of a raised threshold and ensure a smooth on/off run, allow approximately an extra 2-3ft (60-90cm) on the length of your ramp so that it rides smoothly over the threshold.
8. **Step/Door Width:** Never use the ramp when it is too wide to go through the door opening as it will tilt and will be unsafe to use. Never use the ramp if the step on which it is resting is narrower than the ramp itself. This could cause a dangerous sideways lurch.
9. **Slippery Floors:** When using the ramp on a slippery or highly polished floor (ex. Marble), place a thin rubber mat under both ends to prevent slipping. A bath mat with rubber suckers underneath is ideal for this purpose.

IMPORTANT - SAFETY INSTRUCTIONS

The following instructions and advice are necessary to ensure your safety.

Some of these instructions are repeated elsewhere in this User Manual and we recommend that you read and make sure you understand the User Manual fully before using your ramp.

1. **Lifting and Setting up:** If the ramp you are using is more than 5ft (1.5m) long and it weighs more than 35lbs, to avoid injury should not be lifted or maneuvered by one person alone. A weight/length chart is included in this manual.
2. **Setting Up:** Stand the rolled up ramp on its side, remove the strap, and then keeping the ramp on its side, unroll the ramp to its full length before putting it into place. To roll up the ramp, reverse the process and re-fix the strap. This way most of the weight of the ramp is always on the ground during the setup process.
3. **Pinch Guards:** Yellow Pinch Guards are fitted to help prevent fingers being pinched when unrolling or rolling up your ramp. Always keep fingers and hands away from the side rail ends where they abut, and from gaps between the individual treads to avoid injury.
4. **Support Stands:** When using a 30" (76cm) ramp which is 11 ft (3.05m) and longer, a pair of Support Stands **MUST** be used. These stands maintain the load rating and prevent 'bounce' which can be disconcerting for wheelchair users and caregivers.
5. **Gradients (Slope Angle):** The ideal (best) gradient is 1:12. Therefore in an ideal situation the load bearing length of a ramp should be 1 ft of ramp for each 1" of vertical height measured vertically to the ground. This gradient is designed for an unassisted manual wheelchair user requirement. However for many reasons it is often not possible to use this gradient as it would result in an unusable or unmanageable ramp length. Gradients of 1:8 or 1:10 can be used but with able assistance only. Most scooters or electrically powered wheelchairs can manage these gradients but it is always best to check with the manufacturer or supplier first.

How To Split Ramp Into Sections

All Roll-A-Ramp® ramps can be separated into shorter sections. Two options are available and depending on your situation one may be preferable over another. Explanations of both methods are below.

Option 1: Unbolting the link at the desired section

The tools included with your ramp may be used to remove the pair of bolts and nuts connecting each ramp link to the next at any location you choose.

This is done by using the Allen key on the bolt, and the 1/2" box wrench on the nut. (You may use your own 1/2" wrench as well.)

To reconnect the ramp sections together, simply line up the holes on each side of the links to be connected and insert and tighten the nut.

Tightening note: Be sure not to tighten the nut too tightly, as this will not allow for the ramp to use its unique ability to roll up.



Option 2: Using #3275 Quick Connect Pins

Ramp sections may be split at any location we well by using these special pins (*Optional-ordered separately*).

No tools are required to separate the ramp into shorter sections, The pins are simply inserted in place of the bolts on each side of the ramp

Excellent for ramps that are set up for shorter time periods and are taken down.



Adding / Removing Additional Ramp Links

Additional links may be added to lengthen your ramp, if you need a more gradual slope, or removed to make it shorter done.

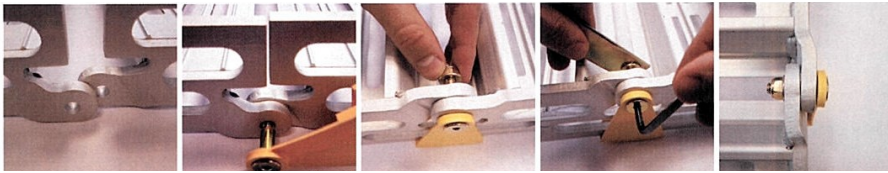

Adding links:

1. With ramp upside down, use the 3/16" Hex Allen Wrench and 1/2" wrench provided to remove the bottom Approach Plate bolts and nuts from each side. Set plate aside for now.
2. Align holes on the link section to be added on each side of ramp and insert bolt and nut, and tighten. *Do not fully tighten ramp must be able to roll.*
3. Re-attach end Approach Plate to ramp end using the two bolts and nuts provided.

Removing links: Reverse the order if removing ramp links

Using the Quick Pins (Optional)

Pins are used to split a ramp into shorter more manageable sections.

Inserting pins: Pins may be inserted with ramp upside down or on its side depending on ramp length and user ability.

1. Align the two ramp sections so that the holes line up and ramp edges are flush.
2. Insert the Quick Pin into the hole, ensuring the pin goes through both ramp sections.
3. Repeat for other side in ramp in same manner.

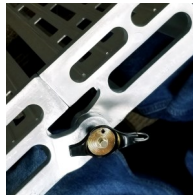

*** NOTE: PINS ARE NOT DESIGNED TO SECURE RAMP SECTIONS TOGETHER DURING TRANSPORT OF RAMP. Remove pins prior to transporting your Roll-A-Ramp®**

Additional Notes:

- 1) Overall length includes approach plates
- 2) Overall length can be adjusted by simply adding or removing links

Roll-A-Ramp Return Policy

- **20% Restocking Fee**
 - 90 days from date of purchase
 - Outbound shipping is not refunded
 - Customer responsible for ramp return
 - Contact Roll-A-Ramp® if assistance is needed

Refund issued upon return of items in acceptable condition.

Full 10-Year Equipment Warranty

DT&J Inc (Roll-A-Ramp®) will replace any defective or worn-out parts for a period of 10 years from the purchase date by the original end user. Products that have been subject to negligence, abuse, improper storage or handling, improper operation, unauthorized modifications, or damages beyond normal wear as determined by DT&J Inc (Roll-A-Ramp®), are not covered. If weight on such products is exceeded, the warranty will be void. This warranty is exclusive and in lieu of all other express warranties or implied warranties, including but not limited to the implied duration of this warranty. DT&J Inc (Roll-A-Ramp®), shall not be liable for consequential or incidental damages whatsoever. This warranty applies to the original end user only.

Warranty issues will be handled by the equipment dealer that you purchased from, or call 866-883-4722.



Support Stand Instructions: Spacers

For ramps 11 ft and longer, support stands are required.

1. Set up ramp to desired location
2. Place support stands beside ramp at midway point (or every 6-7 ft on ramps of 18 ft and longer) and adjust height so that the stands are the same height as the ramp. Hold the T-Slot Nut inside of the ramp element. Move the stand close to that element. Then add the T-Handle bolt with washer from outside through the stand into the sliding block and fix the screw slightly.
3. Turn stand handle so ramp is straight and does not sag, and stand is tight and ramp does not shift up and down when walked on.

Spacers for 12”(30.48cm) ramp models: Spacers hold the ramps parallel to each other to ensure that your 12” (30.48cm) Roll-A-Ramp® stay at the correct width. We can provide you with spacers of various sizes to accommodate any axle width. Spacers are attached by simply snapping onto the ramp as illustrated below.

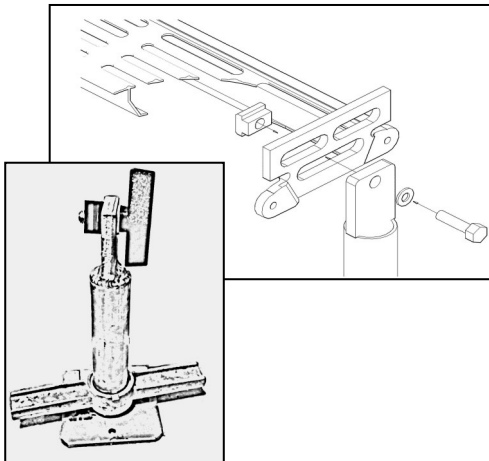
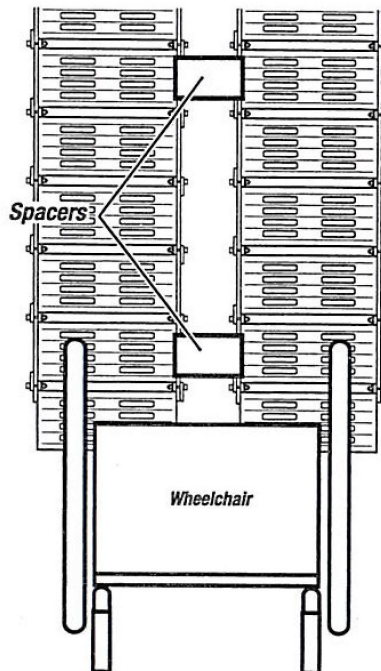
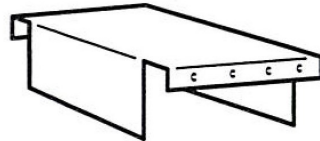

Where Strength and Flexibility Meet

OWNER'S MANUAL

Please read entire manual BEFORE using your Roll-A-Ramp®



DT&J Inc dba Roll-A-Ramp®

1816 4th Ave NW, Unit C,

West Fargo ND 58078 USA

www.rollaramp.com

sales@rollaramp.com

Ph: 701-277-9471 Fax: 701-277-7283

Toll Free: 866-883-4722

Tool List:

3/16" Hex Key Wrench
1/2" (13mm) Wrench
Supplied with your Roll-A-Ramp®

Assembly:

Your Roll-A-Ramp® has been shipped assembled to your specifications. For ramps shipped in multiple boxes, please see addendum enclosed with this manual for final assembly instructions.

General Information:

Roll-A-Ramp® is lightweight, durable, and versatile. Fabricated of strong anodized aerospace aluminum, your Roll-A-Ramp® will provide years of carefree convenience and accessibility when used properly and for its intended purpose.

Using Your Roll-A-Ramp®:

You will notice that yellow pinch-point covers are secured on the head of each bolt. These covers are designed to keep your fingers out of the "pinch zone" and must be on at all times. Do NOT use your ramp(s) without ALL Pinch Point Covers in place.

Never tamper with or remove these covers for any reason as injury may occur.

Ramp Placement: Important

To ensure safety and to prevent damage to your ramp, you must place the first load-bearing link of the elevated end of the ramp on the landing. The approach plate is not a load-bearing link. (see below)

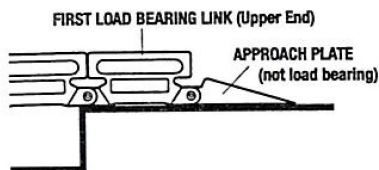

Notice that one end of each ramp is marked "Upper End". This end MUST ALWAYS be the elevated end of the ramp. The links on the upper end of your Roll-A-Ramp® have 1° camber and the links on the lower end have a 0° camber. This 0° loft at the lower end of the ramp allows the wheelchair, machine or other device to get on the ramp on a non-arched plane. As shown below, as the wheelchair goes up the Roll-A-Ramp®, the arching links allow the user to more easily enter a van, porch, or doorway because of the more favorable approach angle. This also ensures clearance for lower devices. Again, by placing the ramp with the "Upper End" at the elevated position, operation will be more favorable.

1° Camber

0° Camber

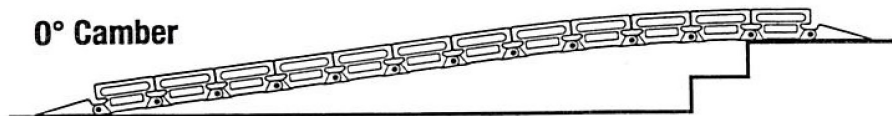

Versatility

Your lightweight Roll-A-Ramp® rolls up and comes with its own handy strap/handle for convenient carrying and storage.

You can configure your Roll-A-Ramp® for many different uses. Besides using it as a roll-up portable ramp system, you can modify your Roll-A-Ramp® so the ramp is rigid or folds in the center for easy handling and storage. Some customers find it more useful to lift the ramp and set in place.

To convert your Roll-A-Ramp® so that it folds in the middle:

- Lay the Roll-A-Ramp® bottom side up.
- Add 3/8" flat or lock washers under the nuts where the ramp will be rigid.
- Fully tighten all bolts using the 1/2" (13mm) Wrench and 3/16" Hex Key Wrench. You may find a socket wrench (1/2") works better.

Do not fully tighten the bolts at the pivot point.

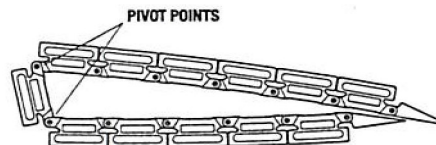

Semi-permanent Installation:

Seg Mount Brackets allow you to secure your Roll-A-Ramp®, yet still leaving it portable - simply lift the ramp to remove.

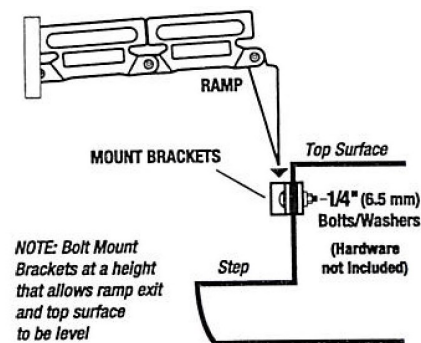

NOTE: Bolt Mount Brackets at a height that allows ramp exit and top surface to be level

The brackets illustrated above can be installed on the vertical section of the last step prior to the landing surface. Accommodates all ramp sizes (2 pairs needed for 12" ramps). This creates a flush entrance/exit from the ramp.

